

T-Piece

with beaded, round and unperforated side profiles, but with connector perforations

WSTR 105.400

EAN Code: 4013339949908
 Smallest packaging unit: 1 pc.

the photorealistic images are to be considered as reference images

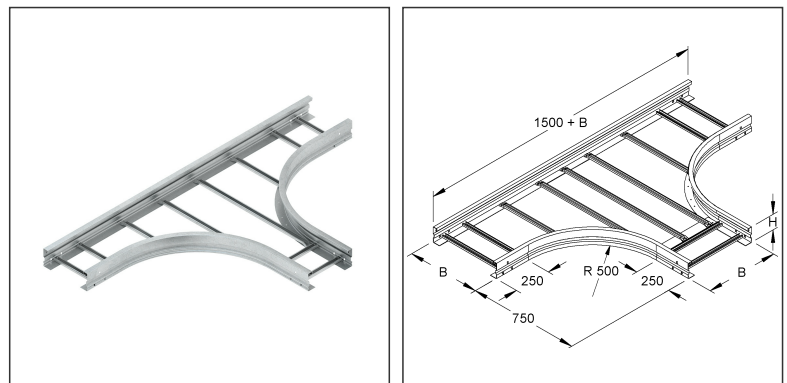

Article Description

T-piece for WSL, 105x400 mm, round, beaded, unperforated, steel, pre-galvanised according to DIN EN 10346

Additional Price Information

Article group	N13
quantity unit	pcs.

Weight

Weight per quantity unit	16 kg / pcs.
Weight in kg per 100	1584 kg / 100pcs.

Technical Datasheet

Long Span Cable Ladder

WSTR 105.400

the photorealistic images are to be considered as reference images

Physical Article Dimensions

Height	105.00 mm
Width	1150 mm
Depth/length	1900 mm

Packing Dimension

1 piece = 1 piece		✓ VP1-smallest packaging unit (PU)			
Lenght	1900 mm	Width	1150 mm	Height	105.00 mm
Gross weight	16 kg	Volume	0,229 m ³		
Min. quantity	1.00 pcs.	Max. Quantity	1.00 pcs.		

Tender Text

T-piece, with beaded, round and unperforated side rails, with connector perforation for connection, dimensionally stable due to riveted C-profile rungs open at the top with 16 mm slot width, for wide span cable trays, for making 90° T-outlets. Please order splice plates WSV 105.390 separately.
 The fitting radii are designed so that the cables can be laid in accordance with DIN/VDE 0298 Part 3.
 Corresponding U-clamps: B... and BK...
 Butt joints must be supported in the immediate vicinity by an appropriate supporting structure.
 Used for : wide span cable ladder WSL 105...
 Dimensions (approx. dimensions)
 Height H x width W : 105 x 400 mm
 Length in main direction : 1500 mm + W
 Length in outgoing direction : 750 mm + W
 Inside rail radius R : 500 mm
 Material : steel, pre-galvanised according to DIN EN 10346
 NIEDAX Model No. : WSTR 105.400
 EP Material_____ EP Wage_____
 Unit price/piece

Safety & Environment

REACH Date	05.11.2025
REACH Info	Conformable
RoHS Info	Conformable

Origin & International Trade

Country of origin	DE
Customs tariff number	73089059

Technical Datasheet

Long Span Cable Ladder

WSTR 105.400

the photorealistic images are to be considered as reference images

Related items

Cover

Model No.	Description
WDRS 20	Turning bolt with locknut acc. to DIN EN ISO 10511, for WSL/WRL, steel, pre-galvanised according to DIN EN 10346, incl. accessories
WTRDV 400	Cover for T-piece for WSL/WRL, width 404 mm, with turning bolt, steel, pre-galvanised according to DIN EN 10346

Connector

Model No.	Description
WSV 105.390	Splice plate, 106,5x390 mm, steel, pre-galvanised according to DIN EN 10346, incl. accessories